

ARIANNA VASO A5N01BI

CE EN 997:2015

GLOBO



Scarico ottimizzato a 4/2,6 litri
Drain 4/2,6 lt

Cod. A5N01BI

Vaso a terra 48.37 h41 cm. Scarico 4 / 2,6 Lt. Installazione distanziata da parete.

Completo di fissaggi. Peso 22 Kg

Floor mounted Wc 48.37 h41 cm. Drain 4 / 2,6 Lt. Wall spaced installation.

Fixing kit included. Weight 22 Kg

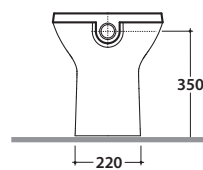
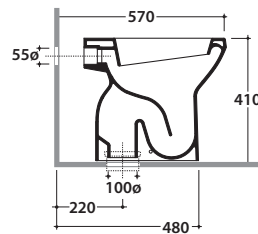
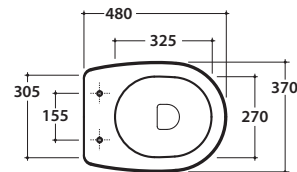

Trattamento antibatterico per sedili in versione bianco lucido
Antibacterial treatment on toilet seats in shiny white

Cod. A5N19BI

Coprivaso in duroplast con chiusura tradizionale. Peso 3 Kg

Duroplast seat-cover with traditional closing system. Weight 3 Kg

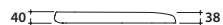
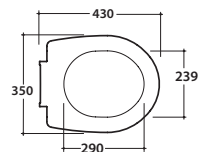
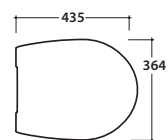

Cod. VA132

Riduttore flusso di scarico.

Flow reductor.

ARIANNA2 VASO BIDET A5N09.BI

GLOBO

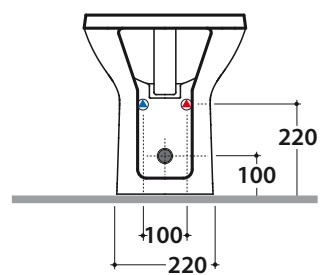
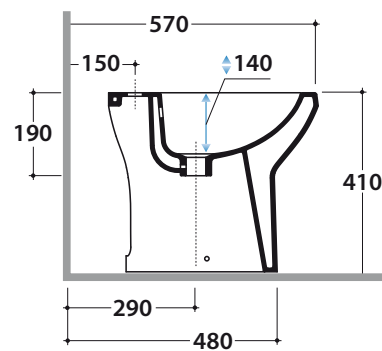
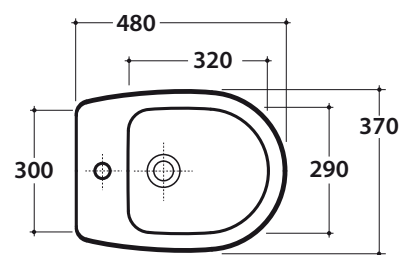

Cod. **A5N09.BI**

Bidet a terra monoforo cm 48. Installazione distanziata da parete. Peso 20 kg.
Floor mounted bidet cm 48. Wall spaced installation. Weight 20 kg.