

DOCCIABELLA PIATTO DOCCIA DB100.AS

CE EN 14527:2016

DIN 51097

Resistenza allo scivolamento con angolo 22° secondo DIN51097 / Slip resistance at an angle of 22° according DIN51097

GLOBO



Effetto antibatterico su ceramica
BATAFORM®
Ceramic antibacterial effect
BATAFORM®



Prodotto smaltato con
CERASLIDE®
Glazed product with
CERASLIDE®

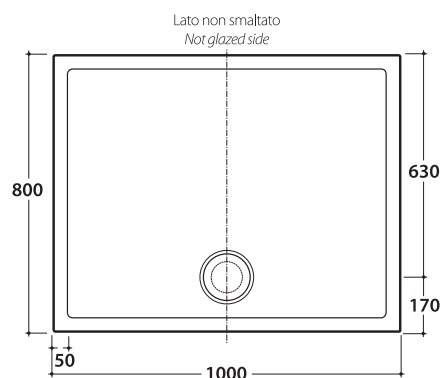

Cod. **DB100.AS**

Piatto doccia 80 x 100 h6,5 cm. in ceramica con texture antiscivolo.
Installazione da appoggio o filo pavimento. Portata di scarico 30 l/m.

Peso 39 Kg

Ceramic shower tray 80 x 100 h6,5 cm. with nonslip finish. Sit-on or floor level installation. With exhaust flow 30 l/m. Weight 39 Kg



Cod. **DBR.AS**

Piletta con copertura in ceramica antiscivolo per piatti doccia con texture antiscivolo. Portata di scarico 30 l/m

Nonslip ceramic siphon drain for nonslip finish shower trays. With exhaust flow 30 l/m



Cod. **DS008**

Piletta cromata sifonata per piatti doccia Ø 90. Portata di scarico 30 l/m

Siphon drain for shower trays Ø 90. With exhaust flow 30 l/m

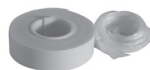

Cod. **PD001**

Kit di montaggio

Installation kit