

GENESIS VASO GES02.BI

GLOBO



Cod. **GES02.BI**

Vaso sospeso con sistema di fissaggio nascosto. Scarico 4,5/3 Lt. Peso 21 kg.
Wall-hung pan provided with hidden fixing system. Drain 4,5/3 Lt. Weight 21 kg.

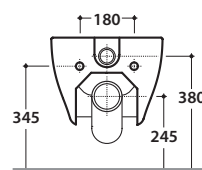
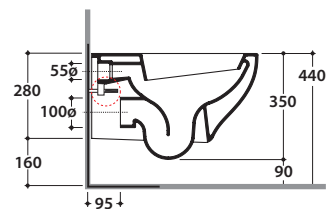
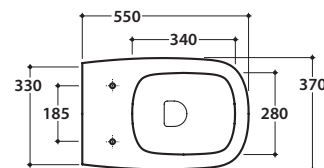
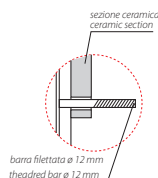

Cod. **GE019.BI**

Coprivaso in termoindurente cerniere cromate. Peso 3 kg.
Thermo-seating seat-cover with chromium-plated hinges. Weight 3 kg.

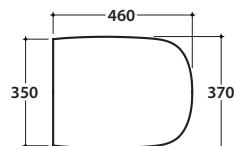

Cod. **GE020.BI**

Coprivaso in termoindurente chiusura rallentata. Peso 3 kg.
Thermo-seating seat-cover with soft-closing system. Weight 3 kg.



Cod. **FI002**

Staffa di fissaggio a "L". Peso 2,5 kg.
Fixing brackets for W/H sanitary. Weight 2,5 kg.



Cod. **PU001**

Protezione antiurto e acustica. Peso 0,2 kg.
Acoustic and crash protection. Weight 0,2 kg.

GENESIS BIDET SOSPESO GES09BI

CE EN 14528:2015

GLOBO



Effetto antibatterico su ceramica
BATAFORM®
Ceramic antibacterial effect
BATAFORM®



Prodotto smaltato con
CERASLIDE®
Glazed product with
CERASLIDE®

Cod. **GES09BI**

Bidet sospeso 55.37 h29,5 cm. Completo di fissaggi. Peso 19 Kg
Wall-hung bidet 55.37 h29,5 cm. Fixing kit included. Weight 19 Kg

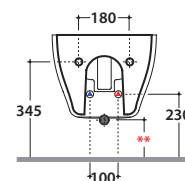
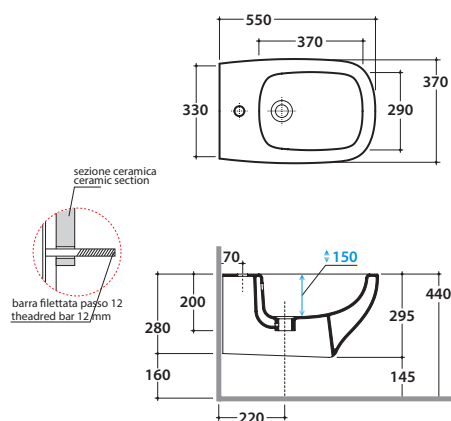

**Per installazione con / for installation with:
Sifone a "S" / siphon "S"-140 mm
Sifone SF052 / siphon SF052- 120 mm



Cod. **FI012BI**

Piletta up and down con tappo in ceramica per bidet. Peso 0,5 Kg
Push open valve drain with ceramic top for bidet. Weight 0,5 Kg



Cod. **FI012CR**

Piletta cromata up and down per bidet. Peso 0,5 Kg
Push open chromed valve drain for bidet. Weight 0,5 Kg



Cod. **PU001**

Protezione antiurto e acustica.
Acoustic and crash protection.



Cod. **FI002**

Staffa di fissaggio a "L". Peso 2,5 Kg
Fixing brackets for W/H sanitary. Weight 2,5 Kg