

INCANTHO VASO INS02.BI

GLOBO

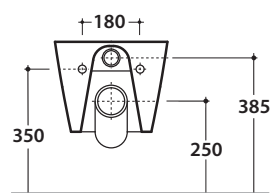
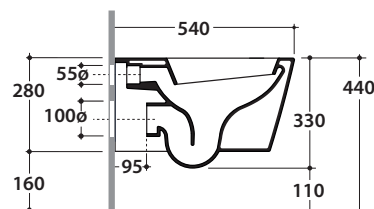
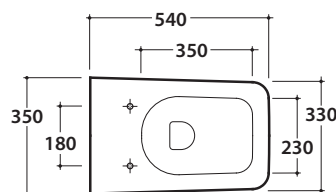

Cod. **INS02.BI**

Vaso sospeso 54.33 con sistema di fissaggio nascosto.

Scarico 4,5/3 Lt. Peso 23 kg.

Wall-hung WC 54.44 provided with hidden fixing system.

Drain 4,5/3 Lt. Weight 23 kg.

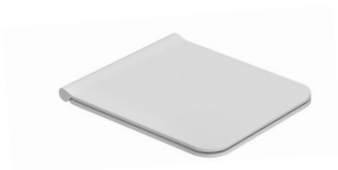

Cod. **IN019BI**

Coprivaso rimovibile in duroplast con chiusura tradizionale. Peso 2,5 Kg

Removable duroplast seat-cover with traditional closing system. Weight 2,5 Kg

Cod. **IN020BI**

Coprivaso rimovibile in duroplast con chiusura rallentata. Peso 2,5 Kg

Removable duroplast seat-cover with soft-closing system. Weight 2,5 Kg

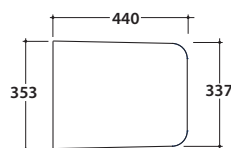

Cod. **VA132**

Riduttore flusso di scarico.

Flow reductor.



Cod. **FI002**

Staffa di fissaggio a "L". Peso 2,5 kg.

Fixing brackets for W/H sanitary. Weight 2,5 kg.



Cod. **PU001**

Protezione antiurto e acustica. Peso 0,2 kg.

Acoustic and crash protection. Weight 0,2 kg.

INCANTHO BIDET INS09.BI

GLOBO



Cod. **INS09.BI**

Bidet sospeso 54.35 cm . Con sistema di fissaggio dal basso nascosto
Completo di fissaggi. Peso 21 kg
*Wall-hung bidet 54.35 cm Provided with lower hidden fixing system.
Fixing kit included. Weight 21 kg.*

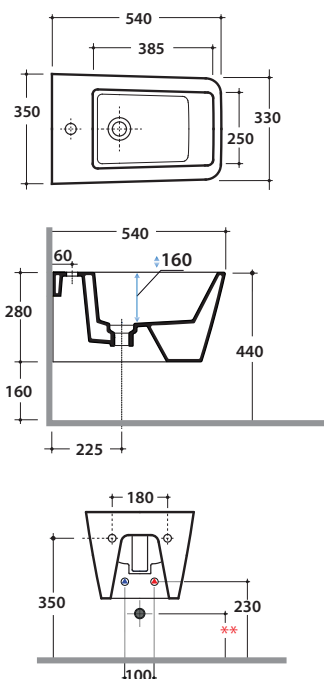

** per installazione con / for installation with:
-sifone a "S"/siphon "S": mm 140
-sifone SF052/siphon SF052: mm 120



Cod. **FI012.BI**

Piletta up and down con tappo in ceramica
Click-clack drain in ceramic



Cod. **FI002**

Staffa di fissaggio a "L". (Barra filettata \varnothing 12). Peso 2,5 kg.
Fixing brackets for W/H sanitary. Threaded bar \varnothing 12. Weight 2,5 kg.

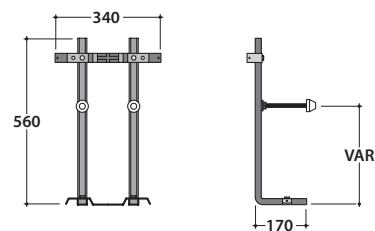

Cod. **PU001**

Protezione antiurto e acustica. Peso 0,2 kg.
Acoustic and crash protection. Weight 0,2 kg.