

# STOCKHOLM VASO SOSPESO LAS03.BI

CE EN 997:2015

# GLOBO



Effetto antibatterico su ceramica  
BATAFORM®  
Ceramic antibacterial effect  
BATAFORM®



Bagno di Colore



Prodotto smaltato con  
CERASLIDE®  
Glazed product with  
CERASLIDE®



Scarico ottimizzato a 4/2,6 litri  
Drain 4/2,6 lt

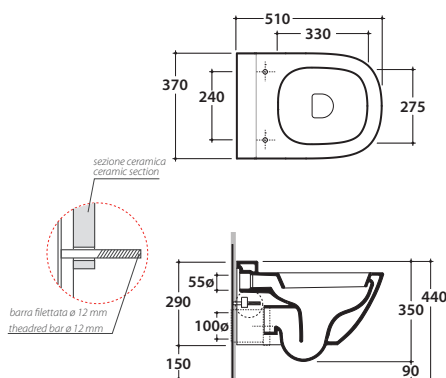

Cod. **LAS03.BI**

Vaso sospeso 51.37 h35 cm. Scarico 4 / 2,6 Lt. Completo di fissaggi. Peso 20 Kg  
Wall-hung Wc 51.37 h35 cm. Drain 4/2,6 Lt. Fixing kit included. Weight 20 Kg

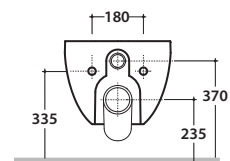

Copriwater con sistema di  
cerniere a sgancio rapido  
Seat-cover with hinge system  
to quick release



Trattamento antibatterico per sedili in  
versione bianco lucido  
Antibacterial treatment on toilet seats  
in shiny white

Cod. **LAR19BI**

Coprivaso rimovibile in duroplast con chiusura tradizionale. Peso 3,5 Kg  
Removable duroplast seat-cover with traditional closing system. Weight 3,5 Kg

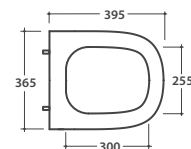
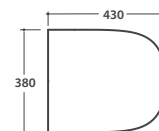

Cod. **LAR20BI**

Coprivaso rimovibile in duroplast con chiusura rallentata. Peso 3,5 Kg  
Removable duroplast seat-cover with soft-closing system. Weight 3,5 Kg



Cod. **VA132**

Riduttore flusso di scarico.  
Flow reductor.



Cod. **PU001**

Protezione antiurto e acustica.  
Acoustic and crash protection.



Cod. **FI002**

Staffa di fissaggio a "L". Peso 2,5 Kg  
Fixing brackets for W/H sanitary. Weight 2,5 Kg

# STOCKHOLM BIDET SOSPESO LAS10.BI

# GLOBO

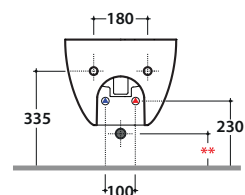
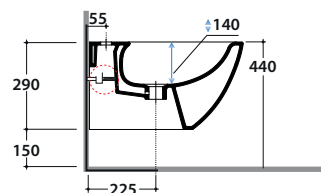
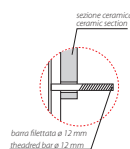
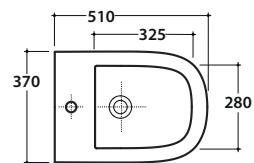

\*\* Per installazione con / For installation with:  
- Sifone a "S" / Siphon "S" - mm 140  
- Sifone SF052 / Siphon SF052 - mm 120

Cod. **LAS10.BI**

Bidet sospeso 51.37 h29 cm. Completo di fissaggi. Peso 18 Kg  
Wall-hung bidet 51.37 h29 cm. Fixing kit included. Weight 18 Kg



Cod. **FI002**

Staffa di fissaggio a "L". (Barra filettata ø12). Peso 2,5 kg.  
Fixing brackets for W/H sanitary. Threaded bar ø 12. Weight 2,5 kg.

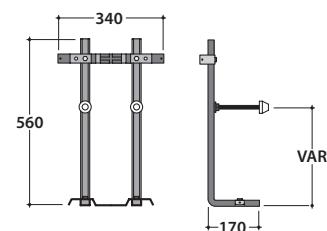

Cod. **PU001**

Protezione antiurto e acustica. Peso 0,2 kg.  
Acoustic and crash protection. Weight 0,2 kg.