

Mobile DUBLINO in MDF cm. 150x45x30

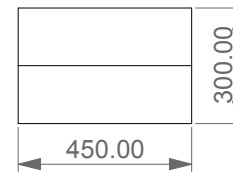

FRONT

LEFT

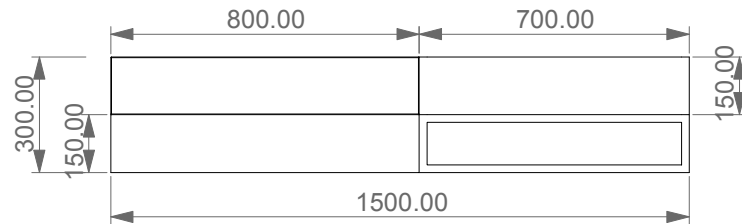
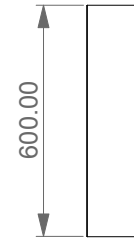
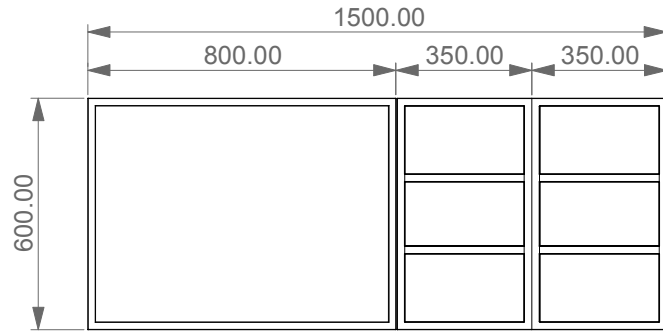
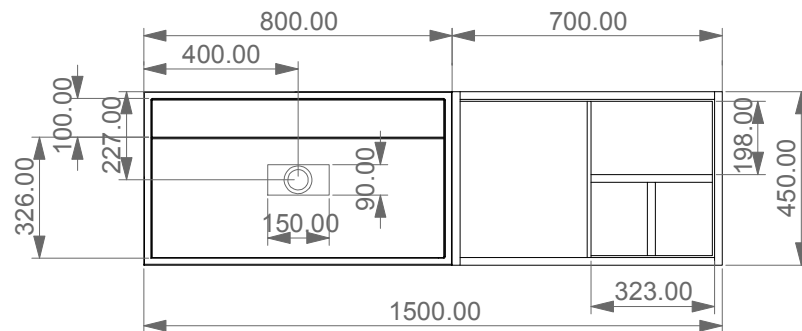
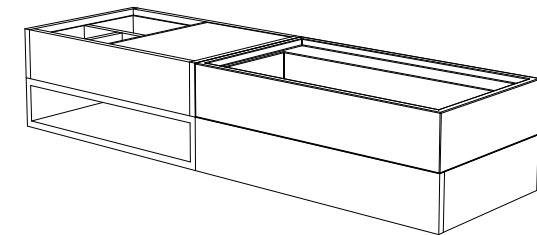
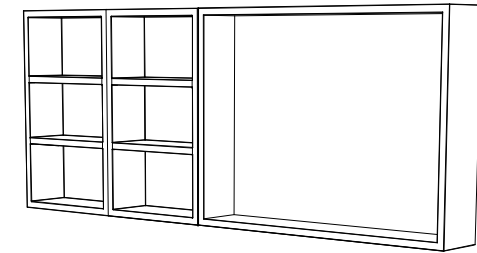

TOP

Designation	
Mobile DUBLINO in MDF cm. 150x45x30	
Scale	<p>This drawing including the respected data may neither be duplicated nor modified nor altered without the consent of GSG Ceramic Design. The use of the data/technical drawings take place at users own risk and under exclusion of any liability of GSG Ceramic Design. The dimensions are not binding; products are subject to changes. Measurement shown may be subjected to small variations or are indicative.</p>
cod. MODUCOMP	